

Ø 5/8" ... 1" (16 ... 26 mm)

**AHE 7.5** Hollow-Shaft  
Incremental Encoder

# AHE 7.5

**Compact hollow-shaft incremental encoder in rugged all-metal die-cast housing with hollow-shaft for monitoring speed or position in drive systems, especially for AC motors.**

- **HÜBNER / SIEI America Incremental Encoders** (Digital-Tachos) have over the years become standard in many areas of industry due to their rugged construction adapted to the application (**Heavy Duty® Technology**):
- Sensing by **opto-ASIC**, compensated for **temperature** and **aging**
- **Electromagnetic Compatibility (EMC)** according to IEC 801-4
- High **vibration** and **shock resistance** meeting IEC 60068-2-6 and IEC 60068-2-27
- **Warranty 2 years** within the conditions of the German Electrical Manufacturer's Association (ZVEI), **ISO 9001** certified

### Special features:

- Compact **aluminium housing**
- Bore **hollow-shaft**  $\varnothing 5 / 8'' \dots 1''$  ( $\varnothing 16 \dots 26$  mm),  $\varnothing 5 / 8''$  and  $1''$  on stock
- Clamping ring left side (right side option)
- Internal **terminal strip**
- **Logic level HTL** with line driver IC (version C) or + 9 ... + 26 V (version R with internal regulator) or **logic level TTL** with supply voltage + 5 V
- Protection **IP 56**
- **Patent** pending

HTL (Version C)

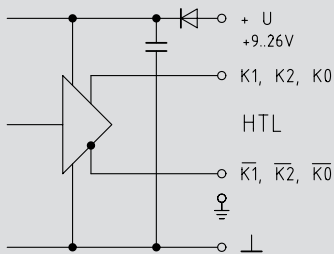

TTL

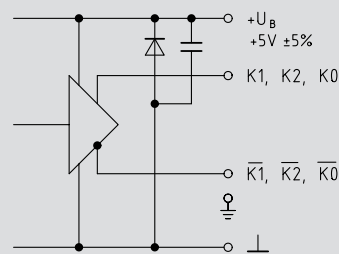

TTL (Version R)

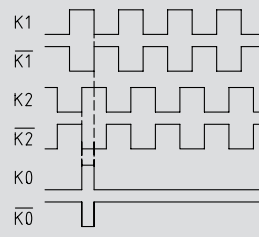
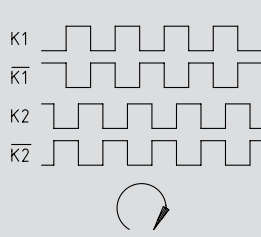
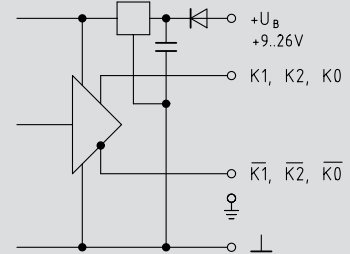

**AHE 7.5 DN ... CI**

two HTL signals displaced by 90° plus marker pulse and inverted signals

**AHE 7.5 DN ... TTL**

as DN ... CI, but TTL signals

**AHE 7.5 DN ... R**

as DN ... TTL, but supply voltage  $U_b = + 9 \dots + 26$  V

**Pulses per revolution**

<b>Pulses per revolution</b>	Z	<b>1 024 stock</b> 1 200, 1 250, 2 048 and 2 500 please consult agent
<b>Switching frequency</b>	f <sub>max.</sub>	120 kHz
<b>Speed max.</b>	rpm	$\frac{7,2 \cdot 10^6}{Z} \leq 10\,000$
<b>Logic level</b>		<b>HTL</b> (Version C) <b>TTL</b> (RS-422)
<b>Supply voltage</b>	U <sub>B</sub>	+ 9 ... + 26 V                      + 5 V ± 5 %                      + 9 ... + 26 V (Version R)
<b>Current consumption at no-load</b>		approx. 100 mA                      approx. 100 mA
<b>Load current per channel max.</b>	I <sub>source</sub> = I <sub>sink</sub>	60 mA average 150 mA peak                      25 mA average 75 mA peak
<b>Output amplitude</b>		U <sub>Low</sub> ≤ 3 V; U <sub>High</sub> ≥ U <sub>B</sub> - 3,5 V                      U <sub>Low</sub> ≤ 0,5 V; U <sub>High</sub> ≥ 2,5 V
<b>Mark space ratio</b>		1:1 ± 20 %
<b>Square wave displacement</b>		90° ± 20°
<b>Rise time</b>		≥ 10 V/μs
<b>Moment of inertia</b>		approx. 180 gcm <sup>2</sup>
<b>Driving torque at operating temperature</b>		approx. 4 Ncm
<b>Load on shaft</b>	max.	axial 40 N    radial 30 N
<b>Vibration proof</b>		≤ 10 g ≈ 100 m/s <sup>2</sup> (10 Hz ... 2 kHz) IEC 60068-2-6
<b>Shock proof</b>		≤ 100 g ≈ 1 000 m/s <sup>2</sup> (6 ms)    IEC 60068-2-27
<b>Temperature range (housing surface)</b>	T	- 30 °C ... + 70 °C
<b>Protection</b>		IP 56                      IEC 34-5
<b>Weight</b>		approx. 320 g

All electrical data at  
T ≤ T<sub>max.</sub>

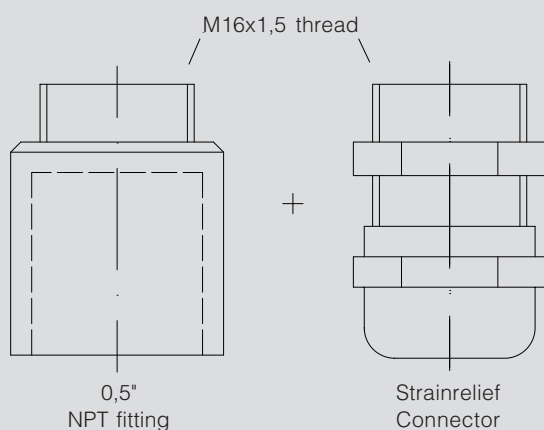

### **Accessories:**

- Torque arm
- Cable HEK 8 and plug
- Spring disk coupling
- Frequency-analogue converter  
HEAG 121 P
- Opto coupler / logic converters  
HEAG 151 → HEAG 154
- Fiber optic links  
HEAG 171 → HEAG 174

# AHE 7.5

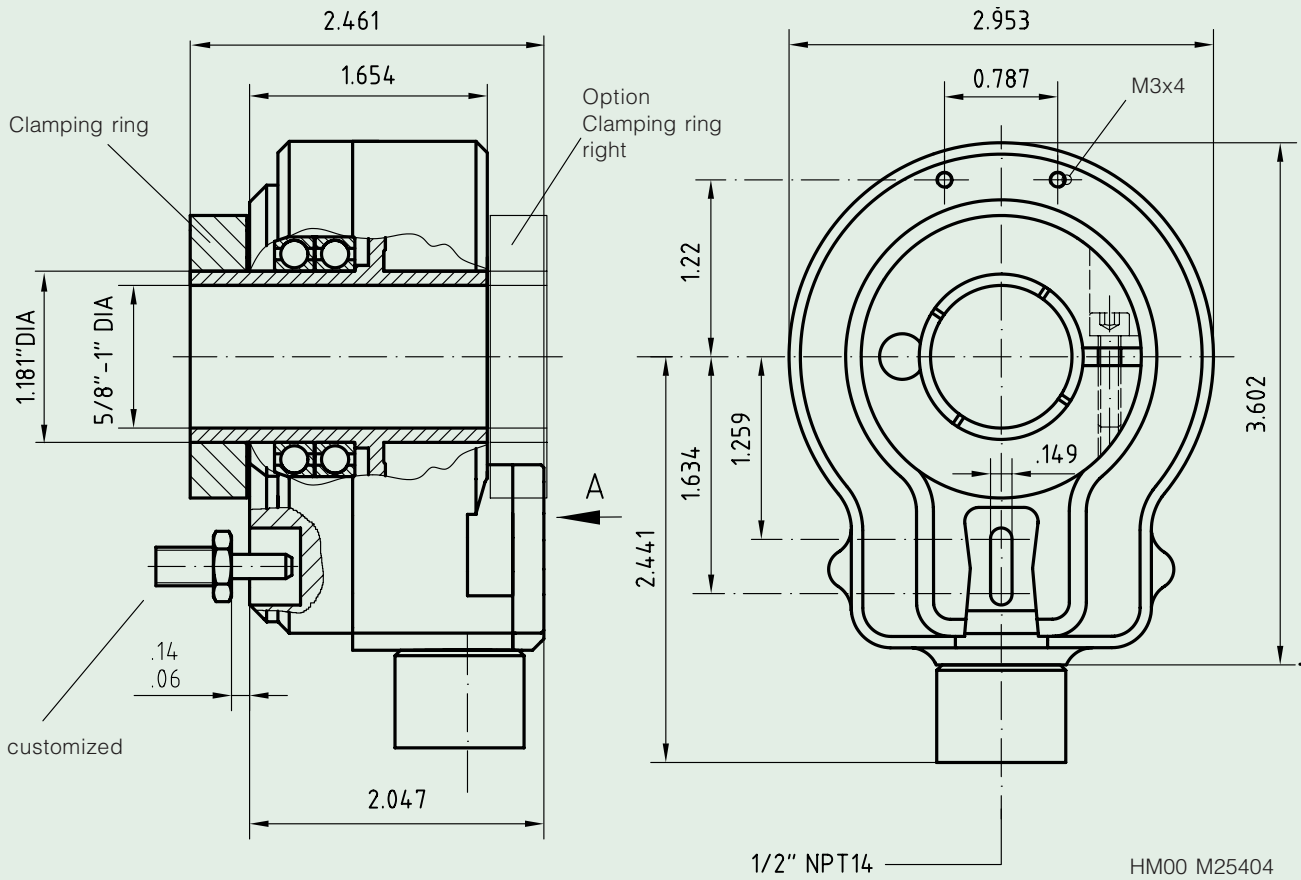

## RAL 7021 (anthracite)

### Mounting Tethers Kits (Torque arms)

Part #	Description
AHE7.5 - T25	25 mm Wide Tether for 5.875" OD Accessory Bolt Circle Marathon Black Max AC Motors, Frames 56 - 284 TENV Only Marathon Blue Max AC Motors, Frames 143 - 256 TENV Only
AHE7.5 - T44	44,5 mm Wide Tether for 7.25" OD Accessory Bolt Circle GE Type KAF AC Motors, Frames 182 - 365

