

Ind. 0 - Revision : 09-2004

2GREA3 108x52R P/N D25-B0

Substitute for Q07-34



Voltage	Frequency	Input power	Current	Capacitor	Airflow	Speed rotation	Noise level	Rotation direction	Operating temperature
V	Hz	Wa	A	µF	m³/h	RPM	dBA	↻	Min / Max
230	50	39	0,18	1,5	175	2 165	51	R	-20°C / +70°C
230	60	48	0,22	1,5	180	2 155	52	R	-20°C / +70°C

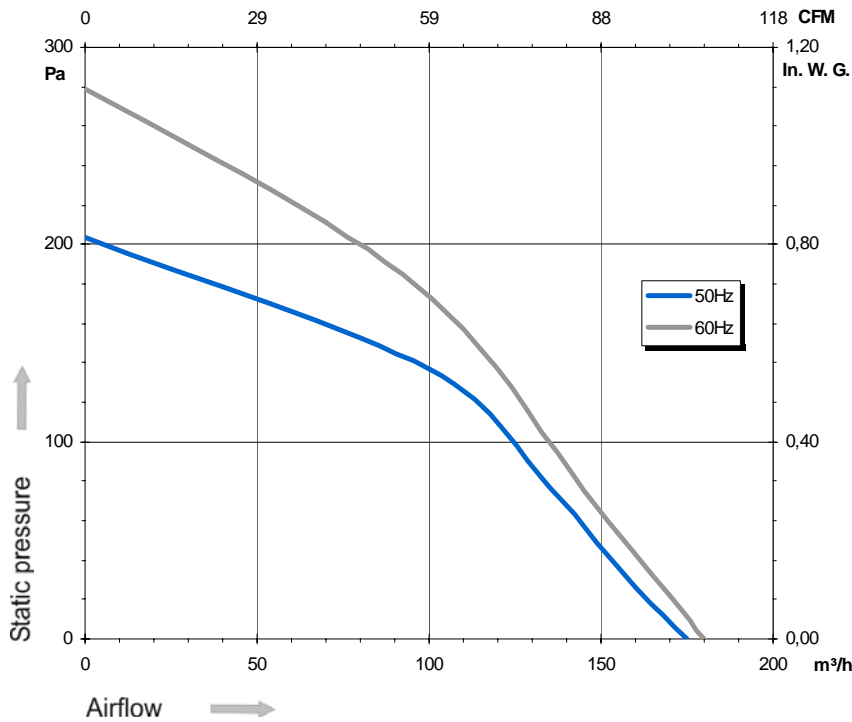
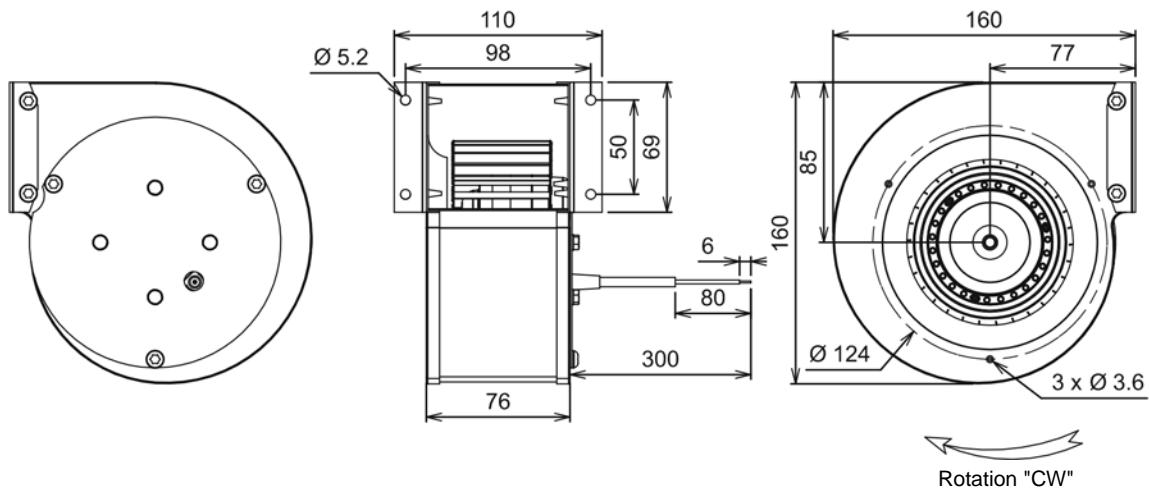

- Ball bearing
- Class F, thermally protected
- IP44 protection
- G2.5 balancing
- Galvanized steel impeller
- Rotor : black paint
- Scroll housing : black paint

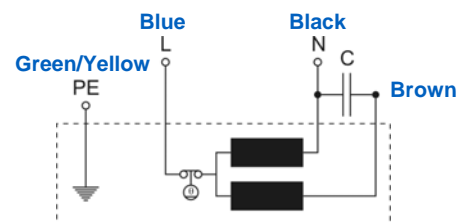

Capacitor for 50Hz	Capacitor for 60Hz
19005-0	19005-0

Non contractual document. All specifications are subject to change without prior notice. Picture for information only.