

For professional use only. Please refer to the conditions of use of our catalogue.

March 2002

2GDS35 133x190L code Z18-10

Voltage	Frequency	Input power	Current	Capacitor	Air flow	Rotational speed	Sound level	Direction of rotation	Max. Air temp.
V	Hz	Wa	A	µF	m ³ /h	rpm	dBA	↻	°C
230	50	215	1,03	4	730	2225	61	L	-20 / +50
230	60	240	1,20	4	570	2540	64	L	-20 / +50

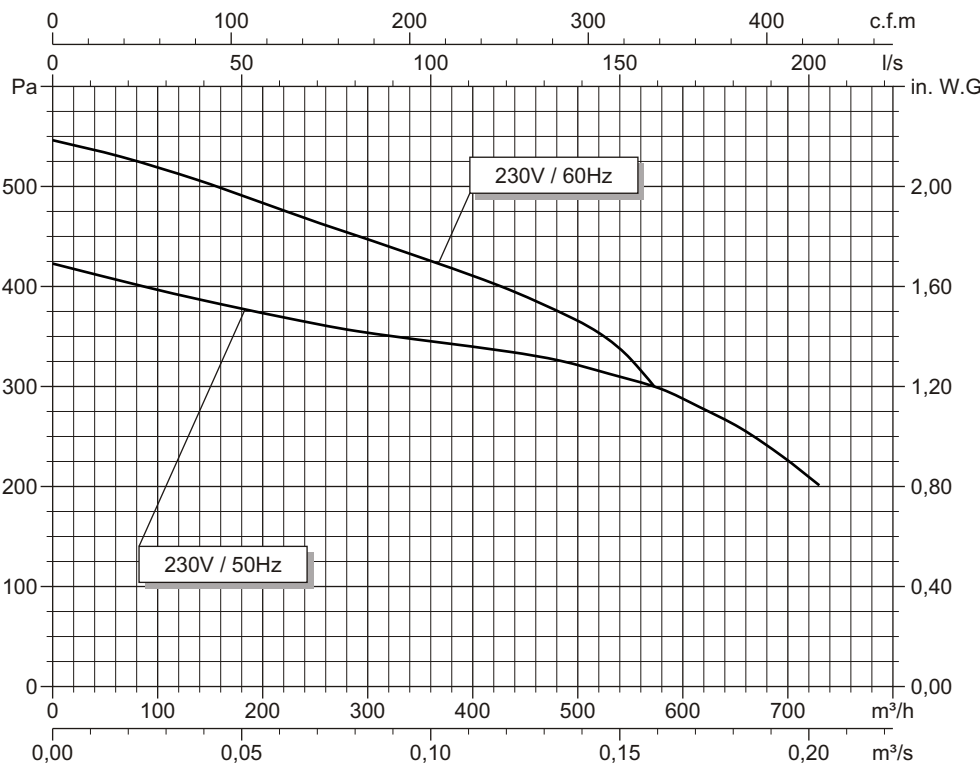
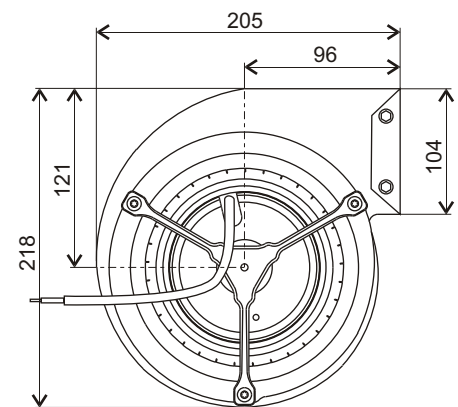
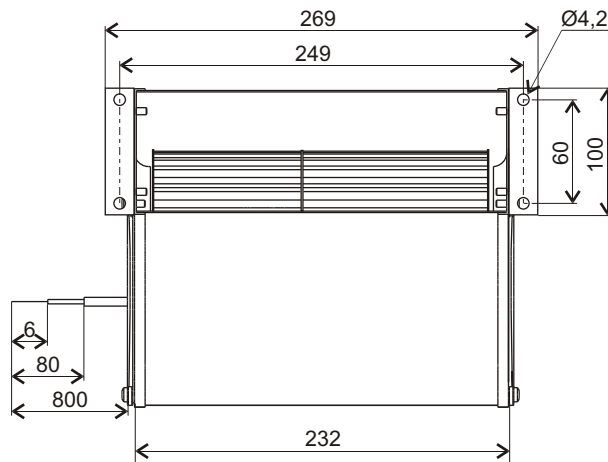

- Ball bearings.
- Cl.F windings protected by thermal cut-out.
- Protection IP 44.
- Balancing G2.5.
- Steel painted black scroll.
- Galvanised steel impeller

Capacitor for 50Hz	Capacitor for 60Hz	Finguer guard
19019-0	19019-0	21338-0

