



Ind. 0 - Revision : 03-2005

VGC48 250V P/N D40-A3



Voltage	Frequency	Input power	Current	Capacitor	Airflow	Speed rotation	Noise level	Rotation direction	Operating temperature
V	Hz	Wa	A	µF	m³/h	RPM	dB(A)	↻	Min / Max
48	-	119	2,47	-	1 825	2 375	64	L	-20°C / +70°C

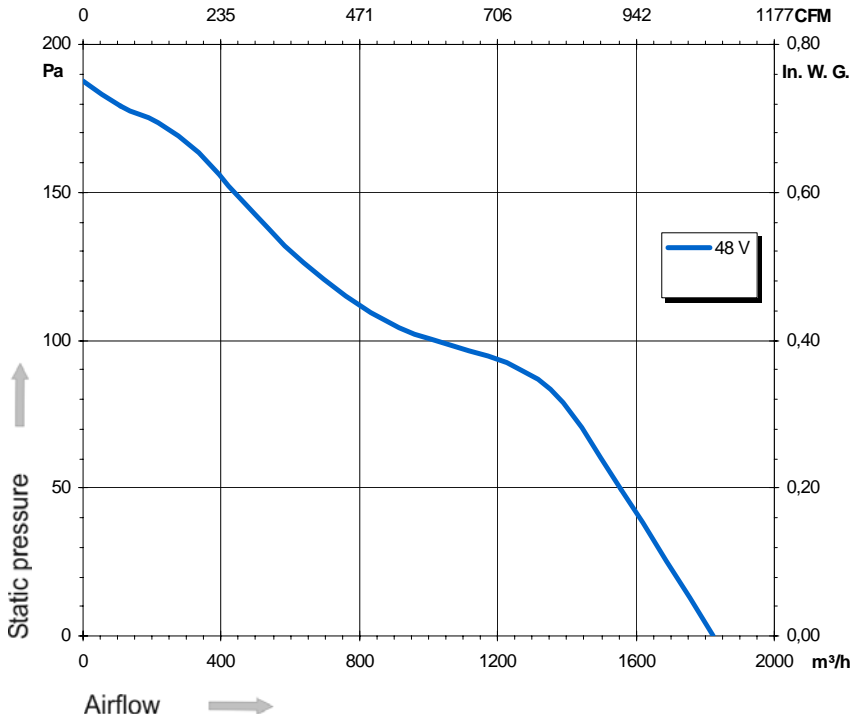
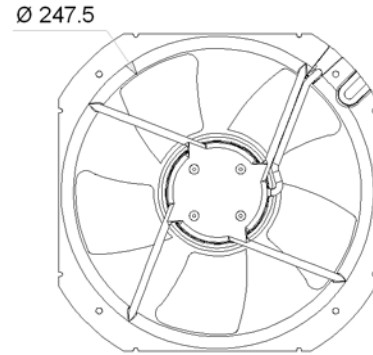
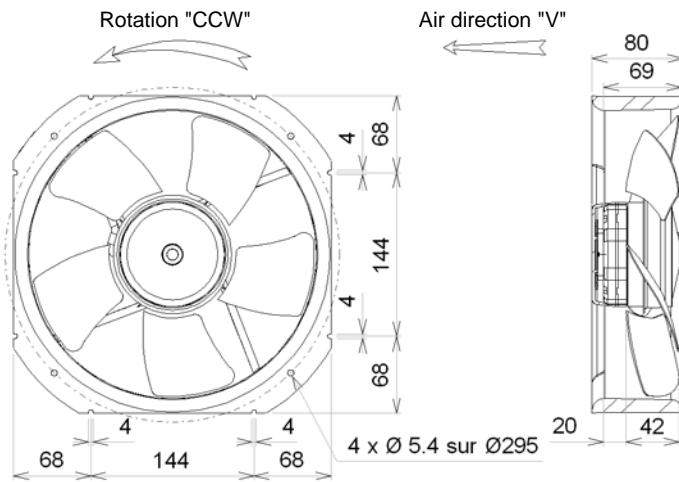

- Nominal voltage 48VDC (36-57VDC)
- Reverse polarity protection
- Soft start
- Locked rotor protection
- Tachometer output (open collector)
- Controlled by 0-10VDC or PWM signal
- IP44 protection
- Aluminium ring
- G6.3 balancing
- Connexion block fixed on ring

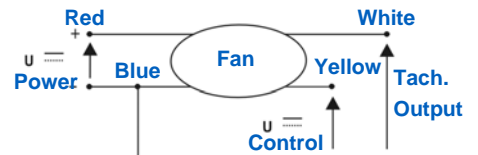

Zinc Coated

21369-0

Non contractual document. All specifications are subject to change without prior notice. Picture for information only.