

Ind. a - Revision : 10-2003

4VGct45 400V

P/N R12-65



Voltage	Frequency	Input power	Current	Capacitor	Airflow	Speed rotation	Noise level	Rotation direction	Operating temperature
V	Hz	Wa	A	µF	m³/h	RPM	dBA	↻	Min / Max
400	50	162	0,36	-	3 725	1 200	70	L	-20°C / +40°C
400	60	204	0,40	-	3 700	1 255	71	L	-20°C / +60°C

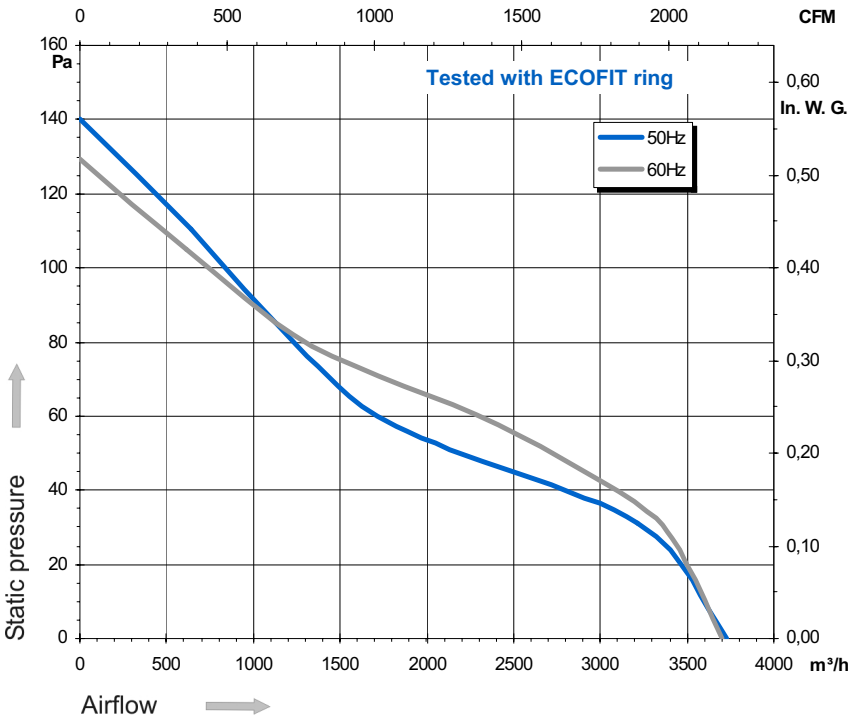
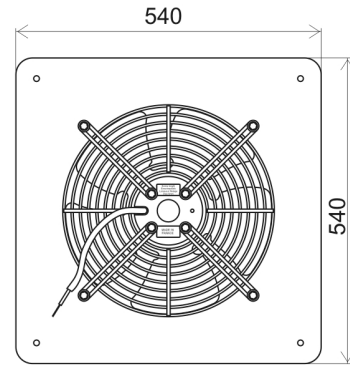
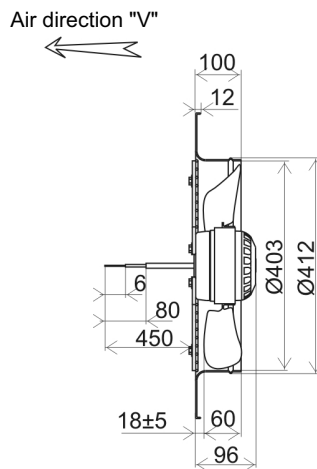
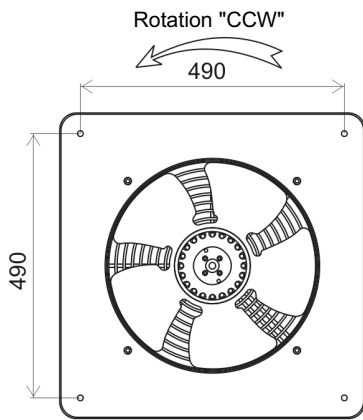

- Ball bearing
- Class F winding
- IP44 protection
- G6.3 balancing
- Zinc coated impeller
- Rotor and impeller : black paint
- Finger guard and ring : black paint

Capacitor for 50Hz Capacitor for 60Hz Connecting box Connector

- - 39658 09145-0

Green/Yellow Blue Black Brown

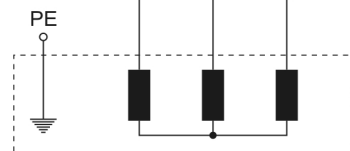

Non contractual document. All specifications are subject to change without prior notice. Picture for information only.